

**Technische gegevens**  
**STM410500550E**

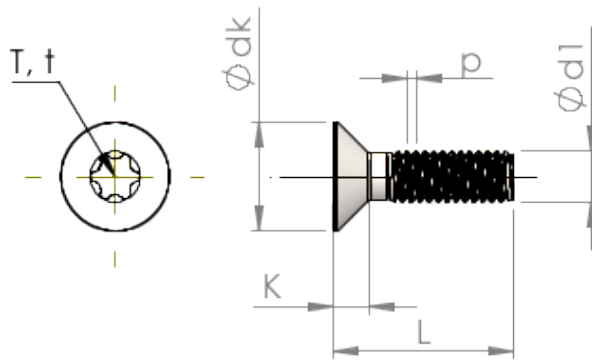

Produktnummer		STM410500550E
Norm		ISO 14581
Materiaal		roestvrij staal A2
Oppervlak		blank, geetst en gepassiveerd
Schroefdraad buiten-Ø	<b>d1</b>	5.00 mm
Spoed	<b>p</b>	0.80 mm
Lengte	<b>L</b>	55.00 ±0.95 mm
Kop-Ø	<b>D</b>	9.30 <sub>-0.36</sub> mm
Cylindrische kophoogte	<b>C</b>	0.75 mm
TX		T25
Indringdiepte	<b>t</b>	1.12 - 1.51 mm
Gewicht		7.023 kg / 1000 stuk
Douane tarief nummer		73 181 575