

## Detalii tehnice STM410500400B

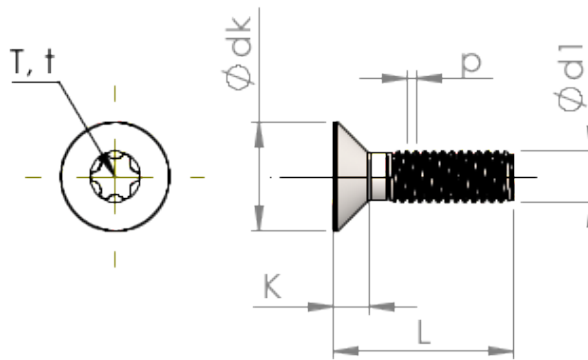

Numărul articolului		STM410500400B
Norma		ISO 14581
Material		oțel, călit
Exterior		zincat, Nichelat, pasivat negru / nu conține Cr-VI, recopt, ermetizat
Diametrul exterior al filetului-Ø	<b>d1</b>	5.00 mm
Pasul filetului	<b>p</b>	0.80 mm
Lungimea	<b>L</b>	40.00 ±0.80 mm
Diametrul capului-Ø	<b>D</b>	9.30 <sub>-0.36</sub> mm
Cap cilindric	<b>C</b>	0.75 mm
hexalobular		T25
Adâncimea de penetrării	<b>t</b>	1.12 - 1.51 mm
Greutate		5.226 kg / 1000 unități
Tariful vamal nr.		73 181 595