

Spec Sheet STM410500300S

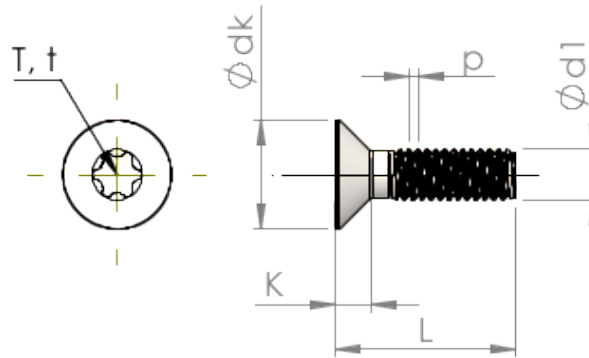

Item Number		STM410500300S
Standard		ISO 14581
Material		steel, hardened
Surface		zinc-plated 5-7 µm, baked, blue / transparent passivated
Thread Outside-Ø	<b>d1</b>	5.00 mm
Thread Pitch	<b>p</b>	0.80 mm
Length	<b>L</b>	30.00 ±0.65 mm
Head-Ø	<b>D</b>	9.30 <sub>-0.36</sub> mm
Cylindrical Head Height	<b>C</b>	0.75 mm
Size Six Lobe		T25
Penetration Depth	<b>t</b>	1.12 - 1.51 mm
Weight		4.029 kg / 1000 pieces
Customs Tariff No		73 181 595