

Spec Sheet STM410500300B

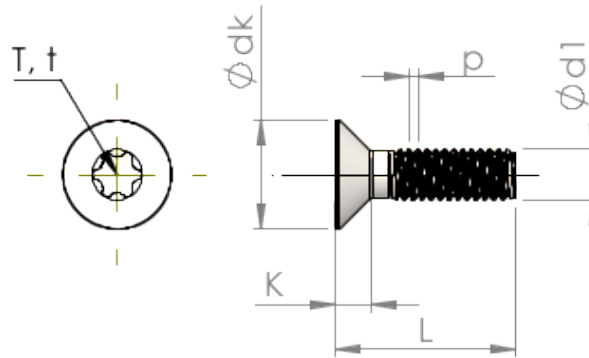

Item Number		STM410500300B
Standard		ISO 14581
Material		steel, hardened
Surface		Zinc-Nickel-plated min. 5µm, passivated black/ Cr-VI-free, baked, sealed
Thread Outside-Ø	d1	5.00 mm
Thread Pitch	p	0.80 mm
Length	L	30.00 ±0.65 mm
Head-Ø	D	9.30 _{-0.36} mm
Cylindrical Head Height	C	0.75 mm
Size Six Lobe		T25
Penetration Depth	t	1.12 - 1.51 mm
Weight		4.029 kg / 1000 pieces
Customs Tariff No		73 181 595