

Detalii tehnice STM410500120B

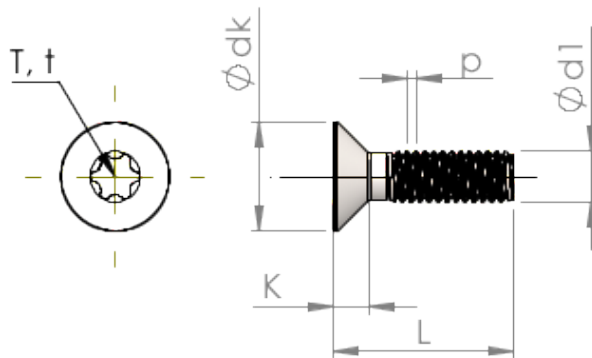

Numărul articolului		STM410500120B
Norma		ISO 14581
Material		oțel, călit
Exterior		zincat, Nichelat, pasivat negru / nu conține Cr-VI, recopt, ermetizat
Diametrul exterior al filetului-Ø	d1	5.00 mm
Pasul filetului	p	0.80 mm
Lungimea	L	12.00 ±0.55 mm
Diametrul capului-Ø	D	9.30 _{-0.36} mm
Cap cilindric	C	0.75 mm
hexalobular		T25
Adâncimea de penetrării	t	1.12 - 1.51 mm
Greutate		1.873 kg / 1000 unități
Tariful vamal nr.		73 181 595