

## Detalii tehnice STM410500100S

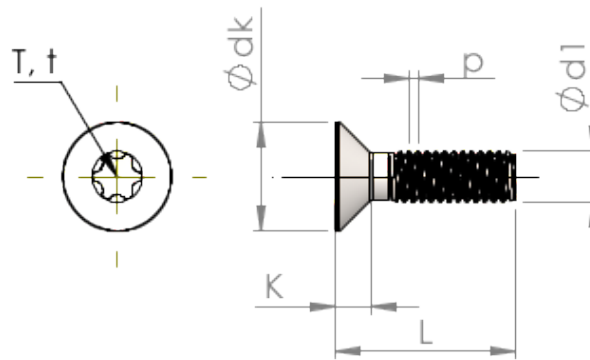

Numărul articolului		STM410500100S
Norma		ISO 14581
Material		oțel, călit
Exterior		zincat 5-7 $\mu\text{m}$ , repect, pasivat transparent/albastru
Diametrul exterior al filetului- $\phi$	<b>d1</b>	5.00 mm
Pasul filetului	<b>p</b>	0.80 mm
Lungimea	<b>L</b>	10.00 $\pm$ 0.45 mm
Diametrul capului- $\phi$	<b>D</b>	9.30 $_{-0.36}$ mm
Cap cilindric	<b>C</b>	0.75 mm
hexalobular		T25
Adâncimea de penetrării	<b>t</b>	1.12 - 1.51 mm
Greutate		1.634 kg / 1000 unități
Tarifal vamal nr.		73 181 595