

Technische gegevens
STM410500080S

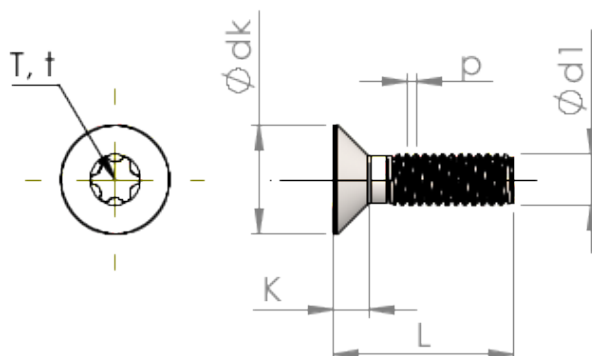

Produktnummer		STM410500080S
Norm		ISO 14581
Materiaal		veredeld staal
Oppervlak		verzinkt 5-7 µm, getempert, blauw / transparant gepassiveerd
Schroefdraad buiten-Ø	d1	5.00 mm
Spoed	p	0.80 mm
Lengte	L	8.00 ±0.45 mm
Kop-Ø	D	9.30 _{-0.36} mm
Cylindrische kophoogte	C	0.75 mm
TX		T25
Indringdiepte	t	1.12 - 1.51 mm
Gewicht		1.394 kg / 1000 stuk
Douane tarief nummer		73 181 595