

Detalii tehnice STM410400150S

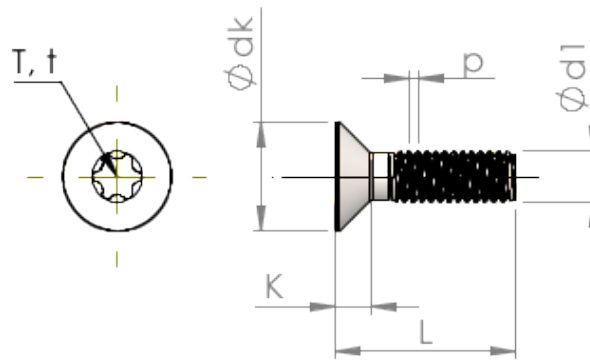

Numărul articolului		STM410400150S
Norma		ISO 14581
Material		oțel, călit
Exterior		zincat 5-7 μm , recopt, pasivat transparent/albastru
Diametrul exterior al filetului- ϕ	d1	4.00 mm
Pasul filetului	p	0.70 mm
Lungimea	L	15.00 \pm 0.55 mm
Diametrul capului- ϕ	D	8.40 $_{-0.36}$ mm
Cap cilindric	C	0.70 mm
hexalobular		T20
Adâncimea de penetrării	t	1.14 - 1.53 mm
Greutate		1.446 kg / 1000 unități
Tarifal vamal nr.		73 181 595