

Technische gegevens
STM410400140B

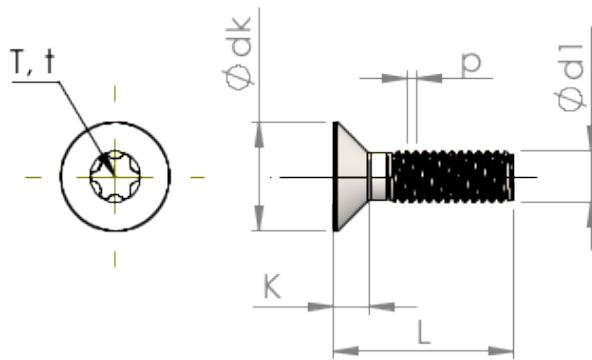

Produktnummer		STM410400140B
Norm		ISO 14581
Materiaal		veredeld staal
Oppervlak		ZnNi zwart-gepassiveerd, getempert, verzegeld
Schroefdraad buiten-Ø	d1	4.00 mm
Spoed	p	0.70 mm
Lengte	L	14.00 ±0.55 mm
Kop-Ø	D	8.40 _{-0.36} mm
Cylindrische kophoogte	C	0.70 mm
TX		T20
Indringdiepte	t	1.14 - 1.53 mm
Gewicht		1.374 kg / 1000 stuk
Douane tarief nummer		73 181 595