

Technische gegevens
STM410400120E

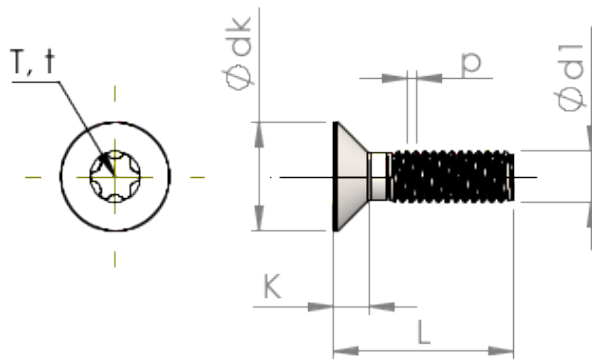

Produktnummer		STM410400120E
Norm		ISO 14581
Materiaal		roestvrij staal A2
Oppervlak		blank, geetst en gepassiveerd
Schroefdraad buiten-Ø	d1	4.00 mm
Spoed	p	0.70 mm
Lengte	L	12.00 ±0.55 mm
Kop-Ø	D	8.40 _{-0.36} mm
Cylindrische kophoogte	C	0.70 mm
TX		T20
Indringdiepte	t	1.14 - 1.53 mm
Gewicht		1.228 kg / 1000 stuk
Douane tarief nummer		73 181 575