

Spec Sheet STM410400120B

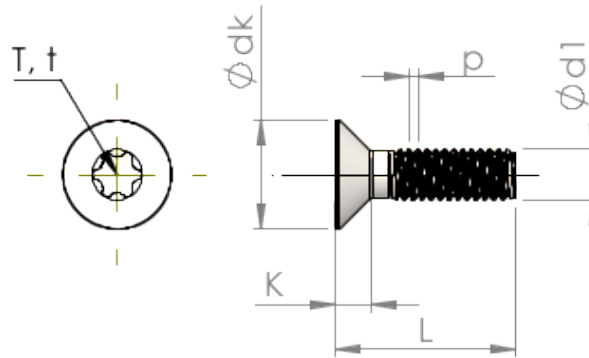

Item Number		STM410400120B
Standard		ISO 14581
Material		steel, hardened
Surface		Zinc-Nickel-plated min. 5µm, passivated black/ Cr-VI-free, baked, sealed
Thread Outside-Ø	d1	4.00 mm
Thread Pitch	p	0.70 mm
Length	L	12.00 ±0.55 mm
Head-Ø	D	8.40 _{-0.36} mm
Cylindrical Head Height	C	0.70 mm
Size Six Lobe		T20
Penetration Depth	t	1.14 - 1.53 mm
Weight		1.228 kg / 1000 pieces
Customs Tariff No		73 181 595