

Technische gegevens
STM410350350S

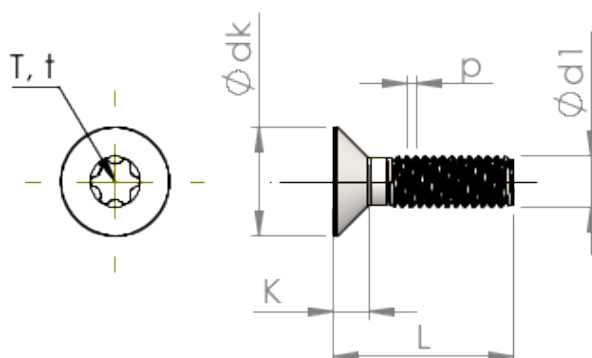

Produktnummer		STM410350350S
Norm		ISO 14581
Materiaal		veredeld staal
Oppervlak		verzinkt 5-7 µm, getempert, blauw / transparant gepassiveerd
Schroefdraad buiten-Ø	d1	3.50 mm
Spoed	p	0.60 mm
Lengte	L	35.00 ±0.80 mm
Kop-Ø	D	7.30 _{-0.36} mm
Cylindrische kophoogte	C	0.65 mm
TX		T15
Indringdiepte	t	1.16 - 1.32 mm
Gewicht		2.266 kg / 1000 stuk
Douane tarief nummer		73 181 595