

**Technische gegevens**  
**STM410350250S**

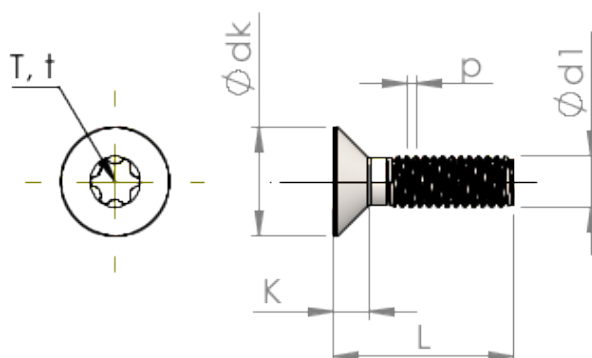

Produktnummer		STM410350250S
Norm		ISO 14581
Materiaal		veredeld staal
Oppervlak		verzinkt 5-7 µm, getempert, blauw / transparant gepassiveerd
Schroefdraad buiten-Ø	<b>d1</b>	3.50 mm
Spoed	<b>p</b>	0.60 mm
Lengte	<b>L</b>	25.00 ±0.65 mm
Kop-Ø	<b>D</b>	7.30 <sub>-0.36</sub> mm
Cylindrische kophoogte	<b>C</b>	0.65 mm
TX		T15
Indringdiepte	<b>t</b>	1.16 - 1.32 mm
Gewicht		1.687 kg / 1000 stuk
Douane tarief nummer		73 181 595