

Technische gegevens
STM410350220E

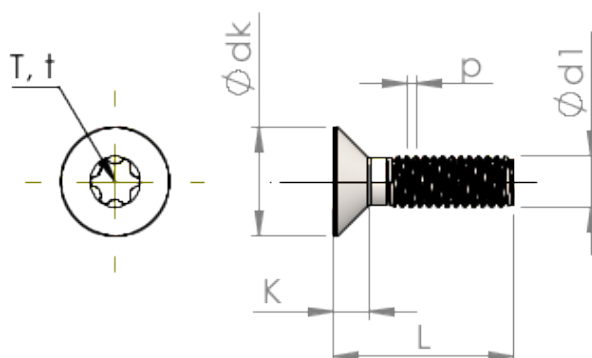

Produktnummer		STM410350220E
Norm		ISO 14581
Materiaal		roestvrij staal A2
Oppervlak		blank, geetst en gepassiveerd
Schroefdraad buiten-Ø	d1	3.50 mm
Spoed	p	0.60 mm
Lengte	L	22.00 ±0.65 mm
Kop-Ø	D	7.30 _{-0.36} mm
Cylindrische kophoogte	C	0.65 mm
TX		T15
Indringdiepte	t	1.16 - 1.32 mm
Gewicht		1.514 kg / 1000 stuk
Douane tarief nummer		73 181 575