

Detalii tehnice STM410350200E

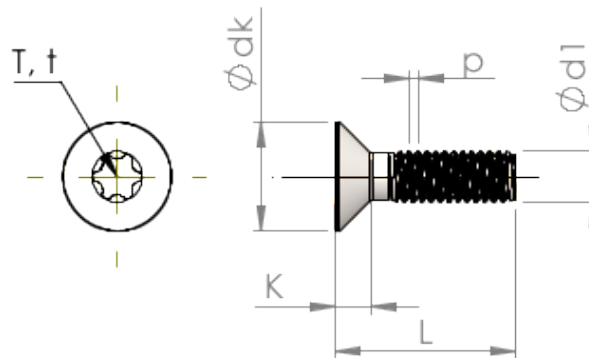

Numărul articolului		STM410350200E
Norma		ISO 14581
Material		oțel inoxidabil A2
Exterior		neacoperit, murat și pasivat
Diametrul exterior al filetului-Ø	d1	3.50 mm
Pasul filetului	p	0.60 mm
Lungimea	L	20.00 ±0.65 mm
Diametrul capului-Ø	D	7.30 _{-0.36} mm
Cap cilindric	C	0.65 mm
hexalobular		T15
Adâncimea de penetrării	t	1.16 - 1.32 mm
Greutate		1.398 kg / 1000 unități
Tarifal vamal nr.		73 181 575