

Spec Sheet STM410350160S

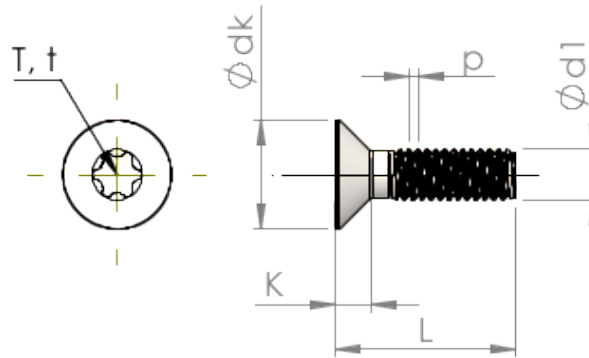

Item Number		STM410350160S
Standard		ISO 14581
Material		steel, hardened
Surface		zinc-plated 5-7 µm, baked, blue / transparent passivated
Thread Outside-Ø	d1	3.50 mm
Thread Pitch	p	0.60 mm
Length	L	16.00 ±0.55 mm
Head-Ø	D	7.30 _{-0.36} mm
Cylindrical Head Height	C	0.65 mm
Size Six Lobe		T15
Penetration Depth	t	1.16 - 1.32 mm
Weight		1.166 kg / 1000 pieces
Customs Tariff No		73 181 595