

Detalii tehnice STM410350150S

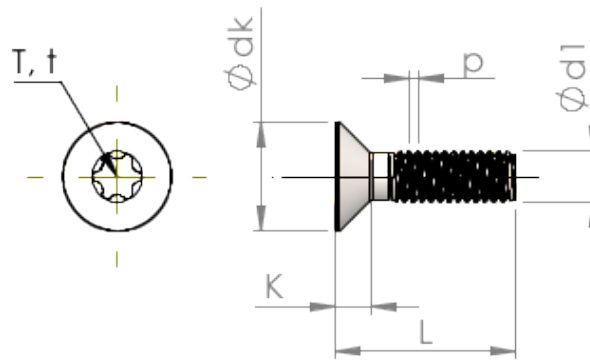

Numărul articolului		STM410350150S
Norma		ISO 14581
Material		oțel, călit
Exterior		zincat 5-7 μm , recopt, pasivat transparent/albastru
Diametrul exterior al filetului- ϕ	d1	3.50 mm
Pasul filetului	p	0.60 mm
Lungimea	L	15.00 \pm 0.55 mm
Diametrul capului- ϕ	D	7.30 $_{-0.36}$ mm
Cap cilindric	C	0.65 mm
hexalobular		T15
Adâncimea de penetrării	t	1.16 - 1.32 mm
Greutate		1.109 kg / 1000 unități
Tarifal vamal nr.		73 181 595