

Spec Sheet STM410350100B

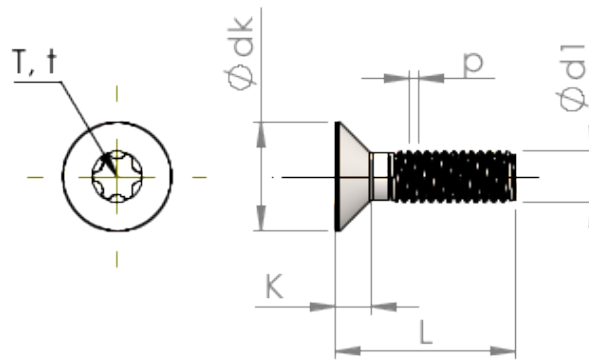

Item Number		STM410350100B
Standard		ISO 14581
Material		steel, hardened
Surface		Zinc-Nickel-plated min. 5µm, passivated black/ Cr-VI-free, baked, sealed
Thread Outside-Ø	<b>d1</b>	3.50 mm
Thread Pitch	<b>p</b>	0.60 mm
Length	<b>L</b>	10.00 ±0.45 mm
Head-Ø	<b>D</b>	7.30 <sub>-0.36</sub> mm
Cylindrical Head Height	<b>C</b>	0.65 mm
Size Six Lobe		T15
Penetration Depth	<b>t</b>	1.16 - 1.32 mm
Weight		0.819 kg / 1000 pieces
Customs Tariff No		73 181 595