

## Detalii tehnice STM410300500B

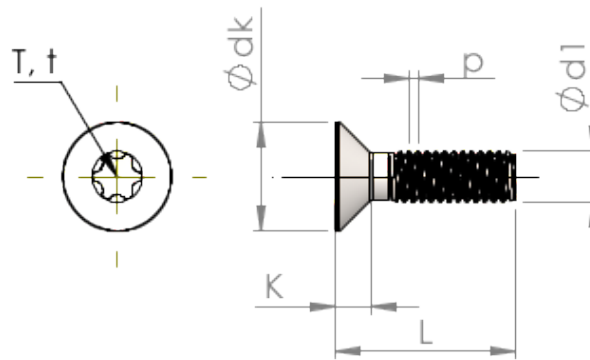

Numărul articolului		STM410300500B
Norma		ISO 14581
Material		oțel, călit
Exterior		zincat, Nichelat, pasivat negru / nu conține Cr-VI, recopt, ermetizat
Diametrul exterior al filetului- $\phi$	<b>d1</b>	3.00 mm
Pasul filetului	<b>p</b>	0.50 mm
Lungimea	<b>L</b>	50.00 $\pm$ 0.80 mm
Diametrul capului- $\phi$	<b>D</b>	5.50 $_{-0.30}$ mm
Cap cilindric	<b>C</b>	0.55 mm
hexalobular		T10
Adâncimea de penetrării	<b>t</b>	0.70 - 0.83 mm
Greutate		2.171 kg / 1000 unități
Tariful vamal nr.		73 181 595