

Technische gegevens
STM410300220S

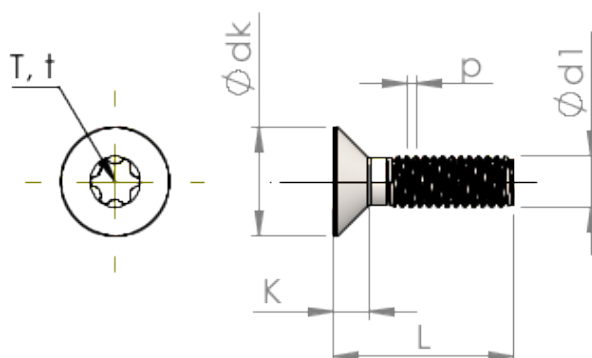

Produktnummer		STM410300220S
Norm		ISO 14581
Materiaal		veredeld staal
Oppervlak		verzinkt 5-7 µm, getempert, blauw / transparant gepassiveerd
Schroefdraad buiten-Ø	d1	3.00 mm
Spoed	p	0.50 mm
Lengte	L	22.00 ±0.65 mm
Kop-Ø	D	5.50 _{-0.30} mm
Cylindrische kophoogte	C	0.55 mm
TX		T10
Indringdiepte	t	0.70 - 0.83 mm
Gewicht		1.007 kg / 1000 stuk
Douane tarief nummer		73 181 595