

**Technische gegevens**  
**STM410300180S**

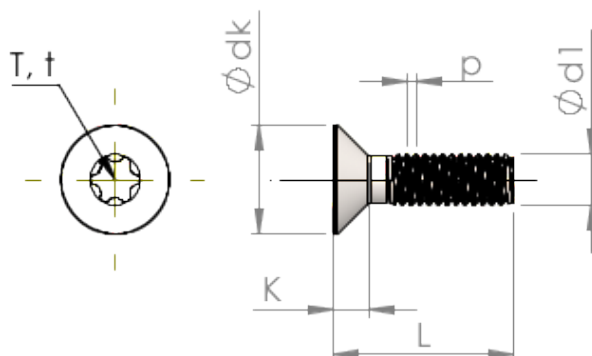

Produktnummer		STM410300180S
Norm		ISO 14581
Materiaal		veredeld staal
Oppervlak		verzinkt 5-7 µm, getempert, blauw / transparant gepassiveerd
Schroefdraad buiten-Ø	<b>d1</b>	3.00 mm
Spoed	<b>p</b>	0.50 mm
Lengte	<b>L</b>	18.00 ±0.55 mm
Kop-Ø	<b>D</b>	5.50 <sub>-0.30</sub> mm
Cylindrische kophoogte	<b>C</b>	0.55 mm
TX		T10
Indringdiepte	<b>t</b>	0.70 - 0.83 mm
Gewicht		0.840 kg / 1000 stuk
Douane tarief nummer		73 181 595