

Spec Sheet STM410300180B

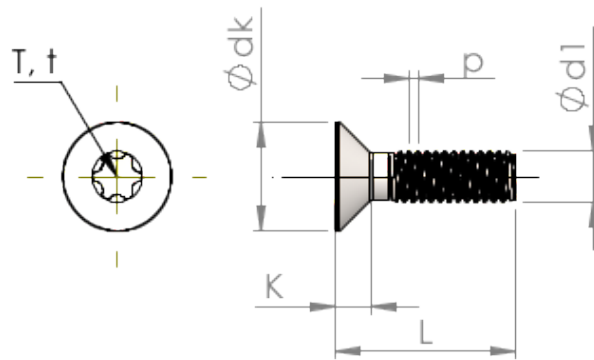

Item Number		STM410300180B
Standard		ISO 14581
Material		steel, hardened
Surface		Zinc-Nickel-plated min. 5µm, passivated black/ Cr-VI-free, baked, sealed
Thread Outside-Ø	d1	3.00 mm
Thread Pitch	p	0.50 mm
Length	L	18.00 ±0.55 mm
Head-Ø	D	5.50 _{-0.30} mm
Cylindrical Head Height	C	0.55 mm
Size Six Lobe		T10
Penetration Depth	t	0.70 - 0.83 mm
Weight		0.840 kg / 1000 pieces
Customs Tariff No		73 181 595