

## Detalii tehnice STM410250160E

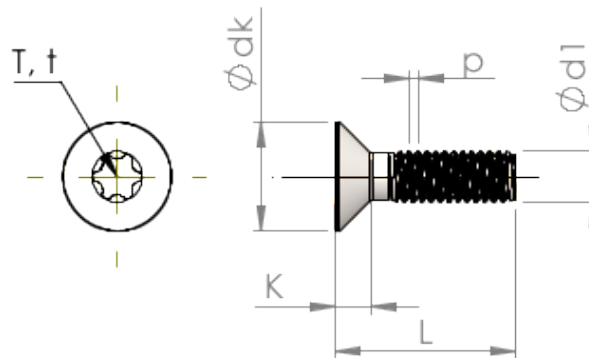

Numărul articolului		STM410250160E
Norma		ISO 14581
Material		oțel inoxidabil A2
Exterior		neacoperit, murat și pasivat
Diametrul exterior al filetului-Ø	<b>d1</b>	2.50 mm
Pasul filetului	<b>p</b>	0.45 mm
Lungimea	<b>L</b>	16.00 ±0.55 mm
Diametrul capului-Ø	<b>D</b>	4.70 <sub>-0.30</sub> mm
Cap cilindric	<b>C</b>	0.55 mm
hexalobular		T8
Adâncimea de penetrării	<b>t</b>	0.66 - 0.79 mm
Greutate		0.504 kg / 1000 unități
Tarifal vamal nr.		73 181 575