

Spec Sheet STM410250160E

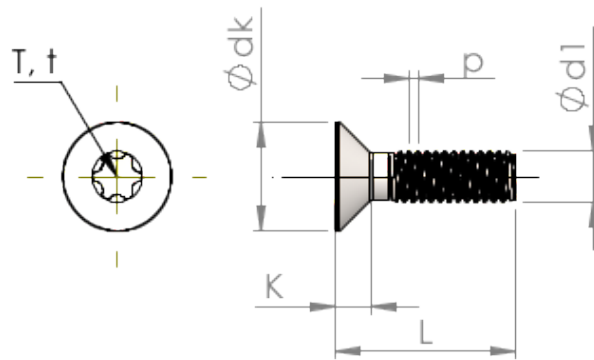

Item Number		STM410250160E
Standard		ISO 14581
Material		stainless-steel A2
Surface		bright, pickled and passivated
Thread Outside-Ø	d1	2.50 mm
Thread Pitch	p	0.45 mm
Length	L	16.00 ±0.55 mm
Head-Ø	D	4.70 _{-0.30} mm
Cylindrical Head Height	C	0.55 mm
Size Six Lobe		T8
Penetration Depth	t	0.66 - 0.79 mm
Weight		0.504 kg / 1000 pieces
Customs Tariff No		73 181 575