

Technische gegevens
STM410250140S

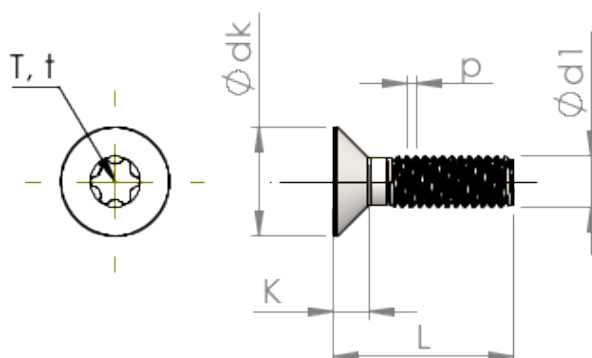

Produktnummer		STM410250140S
Norm		ISO 14581
Materiaal		veredeld staal
Oppervlak		verzinkt 5-7 µm, getempert, blauw / transparant gepassiveerd
Schroefdraad buiten-Ø	d1	2.50 mm
Spoed	p	0.45 mm
Lengte	L	14.00 ±0.55 mm
Kop-Ø	D	4.70 _{-0.30} mm
Cylindrische kophoogte	C	0.55 mm
TX		T8
Indringdiepte	t	0.66 - 0.79 mm
Gewicht		0.448 kg / 1000 stuk
Douane tarief nummer		73 181 595