

Spec Sheet STM410250100S

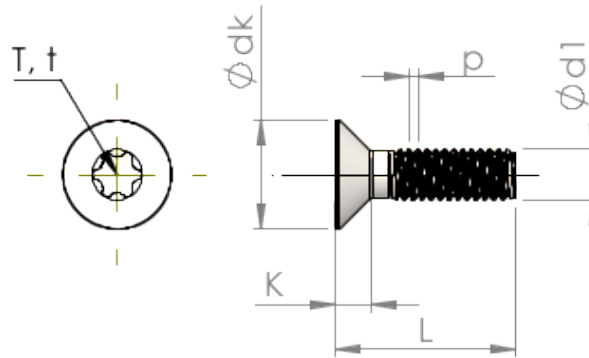

Item Number		STM410250100S
Standard		ISO 14581
Material		steel, hardened
Surface		zinc-plated 5-7 µm, baked, blue / transparent passivated
Thread Outside-Ø	<b>d1</b>	2.50 mm
Thread Pitch	<b>p</b>	0.45 mm
Length	<b>L</b>	10.00 ±0.45 mm
Head-Ø	<b>D</b>	4.70 <sub>-0.30</sub> mm
Cylindrical Head Height	<b>C</b>	0.55 mm
Size Six Lobe		T8
Penetration Depth	<b>t</b>	0.66 - 0.79 mm
Weight		0.337 kg / 1000 pieces
Customs Tariff No		73 181 595