

Technische gegevens
STM410250080B

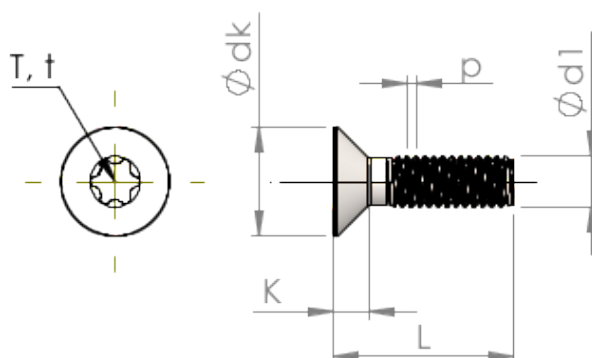

Produktnummer		STM410250080B
Norm		ISO 14581
Materiaal		veredeld staal
Oppervlak		ZnNi zwart-gepassiveerd, getempert, verzegeld
Schroefdraad buiten- \emptyset	d1	2.50 mm
Spoed	p	0.45 mm
Lengte	L	8.00 \pm 0.45 mm
Kop- \emptyset	D	4.70 $_{-0.30}$ mm
Cylindrische kophoogte	C	0.55 mm
TX		T8
Indringdiepte	t	0.66 - 0.79 mm
Gewicht		0.281 kg / 1000 stuk
Douane tarief nummer		73 181 595