

Technische gegevens
STM410250060S

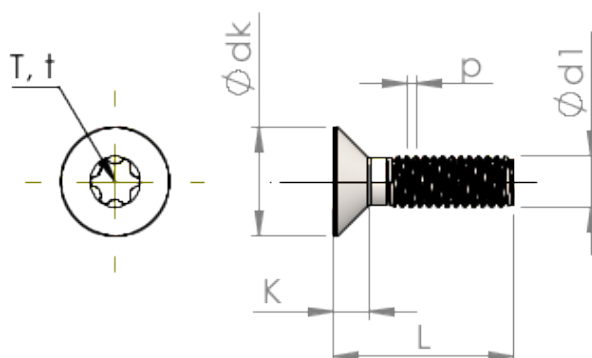

Produktnummer		STM410250060S
Norm		ISO 14581
Materiaal		veredeld staal
Oppervlak		verzinkt 5-7 μm , getempert, blauw / transparant gepassiveerd
Schroefdraad buiten- ϕ	d1	2.50 mm
Spoed	p	0.45 mm
Lengte	L	6.00 \pm 0.38 mm
Kop- ϕ	D	4.70 $_{-0.30}$ mm
Cylindrische kophoogte	C	0.55 mm
TX		T8
Indringdiepte	t	0.66 - 0.79 mm
Gewicht		0.225 kg / 1000 stuk
Douane tarief nummer		73 181 595