

Spec Sheet STM410250060B

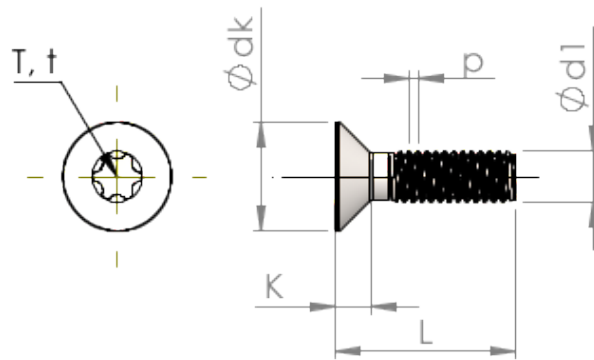

Item Number		STM410250060B
Standard		ISO 14581
Material		steel, hardened
Surface		Zinc-Nickel-plated min. 5µm, passivated black/ Cr-VI-free, baked, sealed
Thread Outside-Ø	d1	2.50 mm
Thread Pitch	p	0.45 mm
Length	L	6.00 ±0.38 mm
Head-Ø	D	4.70 _{-0.30} mm
Cylindrical Head Height	C	0.55 mm
Size Six Lobe		T8
Penetration Depth	t	0.66 - 0.79 mm
Weight		0.225 kg / 1000 pieces
Customs Tariff No		73 181 595