

Spec Sheet STM410200160S

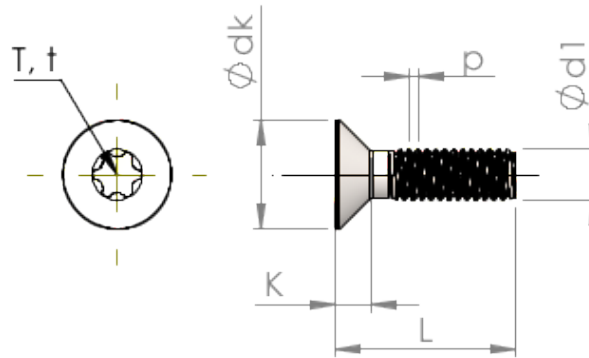

| | | |
|-------------------------|-----------|--|
| Item Number | | STM410200160S |
| Standard | | ISO 14581 |
| Material | | steel, hardened |
| Surface | | zinc-plated 5-7 µm, baked, blue / transparent passivated |
| Thread Outside-Ø | d1 | 2.00 mm |
| Thread Pitch | p | 0.40 mm |
| Length | L | 16.00 ±0.55 mm |
| Head-Ø | D | 3.80 _{-0.30} mm |
| Cylindrical Head Height | C | 0.35 mm |
| Size Six Lobe | | T6 |
| Penetration Depth | t | 0.51 - 0.64 mm |
| Weight | | 0.313 kg / 1000 pieces |
| Customs Tariff No | | 73 181 595 |