

Spec Sheet STM410200120E

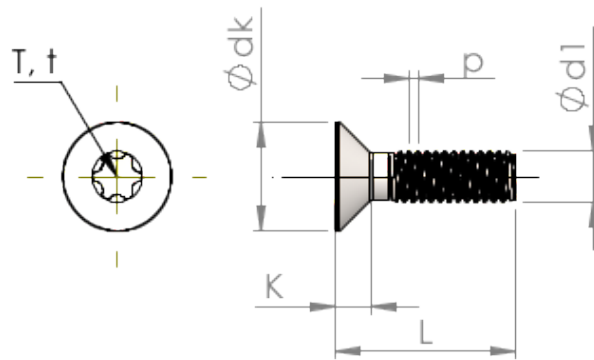

Item Number		STM410200120E
Standard		ISO 14581
Material		stainless-steel A2
Surface		bright, pickled and passivated
Thread Outside-Ø	<b>d1</b>	2.00 mm
Thread Pitch	<b>p</b>	0.40 mm
Length	<b>L</b>	12.00 ±0.55 mm
Head-Ø	<b>D</b>	3.80 <sub>-0.30</sub> mm
Cylindrical Head Height	<b>C</b>	0.35 mm
Size Six Lobe		T6
Penetration Depth	<b>t</b>	0.51 - 0.64 mm
Weight		0.244 kg / 1000 pieces
Customs Tariff No		73 181 575