

**Technische gegevens**  
**STM410200070B**

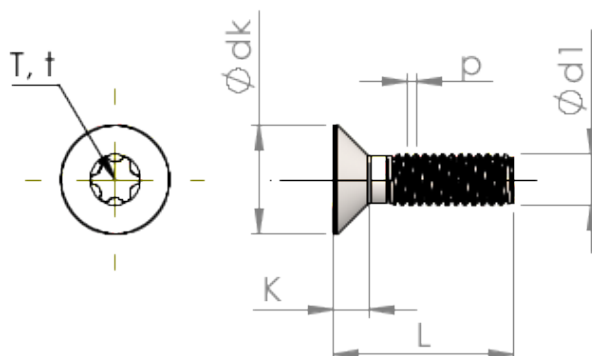

Produktnummer		STM410200070B
Norm		ISO 14581
Materiaal		veredeld staal
Oppervlak		ZnNi zwart-gepassiveerd, getempert, verzegeld
Schroefdraad buiten-Ø	<b>d1</b>	2.00 mm
Spoed	<b>p</b>	0.40 mm
Lengte	<b>L</b>	7.00 ±0.45 mm
Kop-Ø	<b>D</b>	3.80 <sub>-0.30</sub> mm
Cylindrische kophoogte	<b>C</b>	0.35 mm
TX		T6
Indringdiepte	<b>t</b>	0.51 - 0.64 mm
Gewicht		0.156 kg / 1000 stuk
Douane tarief nummer		73 181 595