

Technische gegevens
STM410200060S

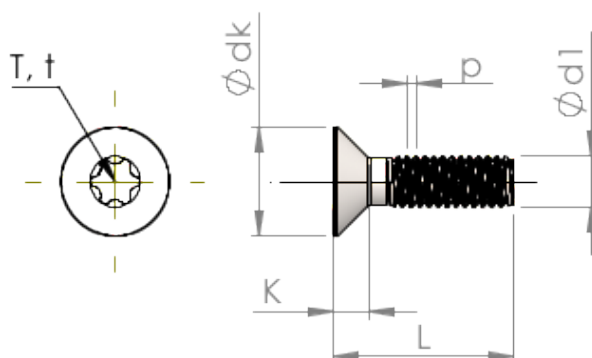

Produktnummer		STM410200060S
Norm		ISO 14581
Materiaal		veredeld staal
Oppervlak		verzinkt 5-7 µm, getempert, blauw / transparant gepassiveerd
Schroefdraad buiten-Ø	d1	2.00 mm
Spoed	p	0.40 mm
Lengte	L	6.00 ±0.38 mm
Kop-Ø	D	3.80 _{-0.30} mm
Cylindrische kophoogte	C	0.35 mm
TX		T6
Indringdiepte	t	0.51 - 0.64 mm
Gewicht		0.139 kg / 1000 stuk
Douane tarief nummer		73 181 595