

Spec Sheet STM410200050S

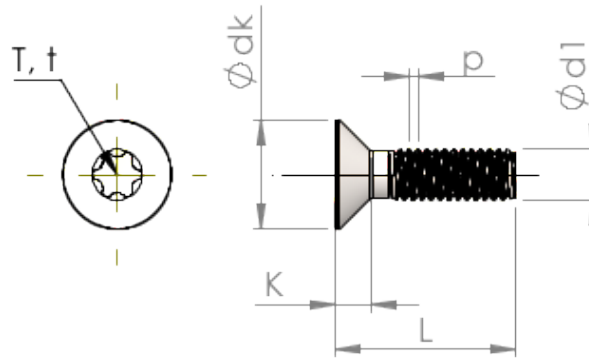

Item Number		STM410200050S
Standard		ISO 14581
Material		steel, hardened
Surface		zinc-plated 5-7 µm, baked, blue / transparent passivated
Thread Outside-Ø	d1	2.00 mm
Thread Pitch	p	0.40 mm
Length	L	5.00 ±0.38 mm
Head-Ø	D	3.80 _{-0.30} mm
Cylindrical Head Height	C	0.35 mm
Size Six Lobe		T6
Penetration Depth	t	0.51 - 0.64 mm
Weight		0.121 kg / 1000 pieces
Customs Tariff No		73 181 595