

Technische gegevens
STM410160060E

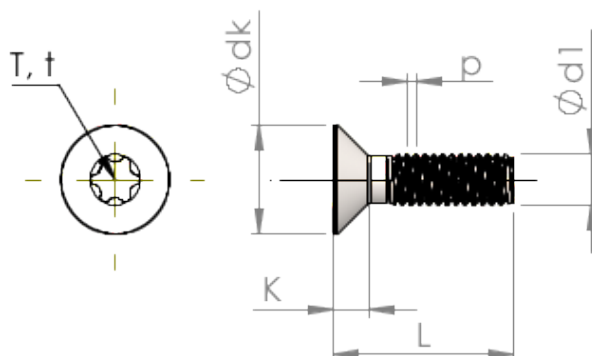

Produktnummer		STM410160060E
Norm		ISO 14581
Materiaal		roestvrij staal A2
Oppervlak		blank, geetst en gepassiveerd
Schroefdraad buiten-Ø	d1	1.60 mm
Spoed	p	0.35 mm
Lengte	L	6.00 ±0.38 mm
Kop-Ø	D	3.35 _{-0.30} mm
Cylindrische kophoogte	C	0.35 mm
TX		T5
Indringdiepte	t	0.51 - 0.64 mm
Gewicht		0.083 kg / 1000 stuk
Douane tarief nummer		73 181 575