

Technische gegevens
STM410160050S

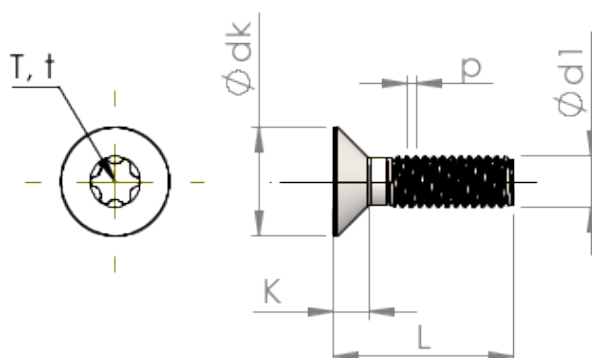

Produktnummer		STM410160050S
Norm		ISO 14581
Materiaal		veredeld staal
Oppervlak		verzinkt 5-7 μm , getempert, blauw / transparant gepassiveerd
Schroefdraad buiten- \emptyset	d1	1.60 mm
Spoed	p	0.35 mm
Lengte	L	5.00 \pm 0.38 mm
Kop- \emptyset	D	3.35 $_{-0.30}$ mm
Cylindrische kophoogte	C	0.35 mm
TX		T5
Indringdiepte	t	0.51 - 0.64 mm
Gewicht		0.074 kg / 1000 stuk
Douane tarief nummer		73 181 595